

Intelligent Syringe Pump **3-Year Warranty**
ISPLab01



Introduction

The intelligent syringe pump with infusion/withdrawal mode, stainless steel body, and 4.3" color LCD screen is easy to operate. It can install and fix different types of injectors or syringes, and it is suitable for transferring micro flow rates with high precision (non-medical).

Features

- Online flow rate modification function: the pump is running, without stopping, adjust the flow rate at any time to meet complex application.
- Colorful LCD display: Friendly interface, large-screen LCD display every technical parameter in real time.
- Input injector inner diameter function: Can choose the injector from the list or input the injector inner diameter directly.
- Two measurement modes for selection: Infusion volume --- Infusion rate, Infusion volume --- Infusion time.
- 4 different working modes: Infusion, withdrawal, infusion/withdrawal, withdrawal/infusion, continuous and additional mode (infusion/withdrawal, then exclude bubble). The parameters of each working mode saving separately.
- Protection function: The pump will stall and give an alarm when the drive structure of the pump is blocked.

OSD

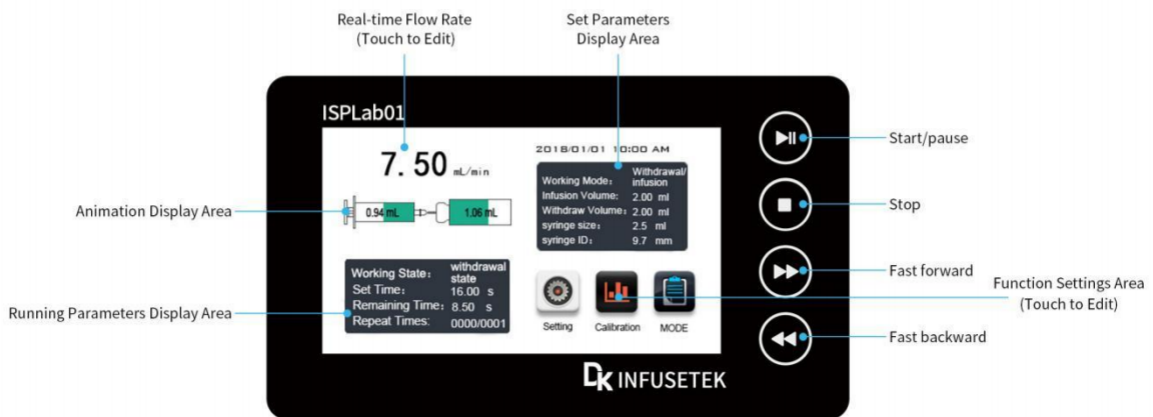

■ Technical Parameter

Working mode	Infusion, withdrawal, infusion/withdrawal, withdrawal/infusion
Channel number	1
Syringe size	0.5μL-150mL
Syringe selection	Syringe size and customized diameter
Linear speed range	1μm/min-132mm/min (Flow rate=Linear speed * syringe inner cut area)
Min. linear rate	1μm/min
Linear force	12-25kgf, adjustable
Max. stroke	140mm
Stroke resolution	0.078μm/μstep
Accuracy	Error $\leq \pm 0.3\%$ (Stroke $\geq 30\%$ of maximum stroke)
Back distance	0.01-10mm
Stored modes	Can save at most 60 modes
Display	Industrial grade 4.3" LCD color display
Control method	Touch screen and Mechanical keypad
Power-off memory	Display the previous data parameter after power supply again
Output	OC gate signal output, used to indicate running status and direction
External control	Start/stop signal, without drawal and infusion signal, active switch signal (5V-24V) Start/stop signal, passive switch signal, such as foot pedal switch
Communication interface	RS232/RS485, Modbus protocol(RTU mode)
Power supply	AC90-264V/65W
Condition temperature	0-40°C
Relative humidity	<80%
Dimension(mm)	282*215*148
Weight	4.44kg

■ Applicable Syringes

Plastic Syringe	Inside Diameter(mm)	Flow Rate($\mu\text{L}/\text{min}$ - mL/min)	
		ISPLab01/ISPLab02	ISPLab04-ISPLab12
1.0mL	4.70	0.0173-2.2889	0.0173-2.2889
2.0mL	8.95	0.0628-8.3002	0.0628-8.3002
5.0mL	12.36	0.1199-15.8299	0.1199-15.8299
10mL	14.90	0.1742-23.0046	0.1742-23.0046
20mL	19.20	0.2893-38.1984	---
30mL	22.00	0.3799-50.1520	---
50mL	29.20	0.6693-88.3505	---
60mL	29.20	0.6693-88.3505	---
100mL	32.00	0.8042-106.1544	---
150mL	40.00	1.2566-165.8712	---

Micro Syringe	Inside Diameter(mm)	Flow Rate(nL/min - $\mu\text{L}/\text{min}$)	
		ISPLab01/ISPLab02	ISPLab04-ISPLab12
0.5 μL	0.10	0.008-1.0296	---
1 μL	0.15	0.018-2.3232	---
2 μL	0.20	0.031-4.1448	---
5 μL	0.35	0.096-12.6984	---
10 μL	0.50	0.2-25.8	0.2-25.8
25 μL	0.80	0.5-66.4	0.5-66.4
50 μL	1.10	1-125.4	1-125.4
100 μL	1.60	2-265.4	2-265.4

■ **Syringe Pump External Control Schematic**

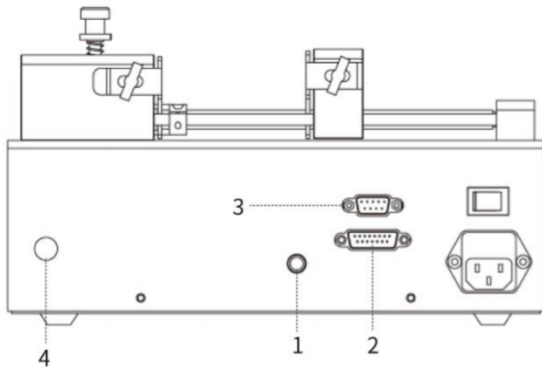

- 1-Foot pedal connector: Connect with foot pedal switch
- 2-15 Pin connector: External input and output
- 3-9 pin connector: RS232 and RS485
- 4-Ground pole

■ **Dimension Drawing (Unit:mm)**

