



# IP66 Industrial Peristaltic Pump

Model : HPM100-SS/AMC

Flow Rate : 0.0002-65mL/min

IP rate : IP66



## Introduction

- Equipped with a 4.3-inch color LCD touchscreen.
- Features real-time animation to display current operating status.
- Flow rate data, preset parameters, and system configurations are all displayed on a single screen.
- Built-in smart calibration function.
- Supports multiple external control modes to easily meet remote operation requirements.
- Features a three-level user authority management system.

## Product Features

- The external control interface features internal and external circuit isolation, minimizing electromagnetic interference and accidental damage to ensure the safe operation of the main control system and connected equipment.
- Designed to meet GMP certification requirements; the stainless steel housing is sleek, easy to clean, and simple to disinfect.
- The entire unit features an IP66 protection rating, ensuring long-term stable operation.



## Control Interface

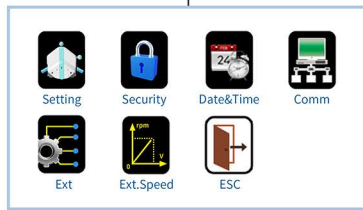
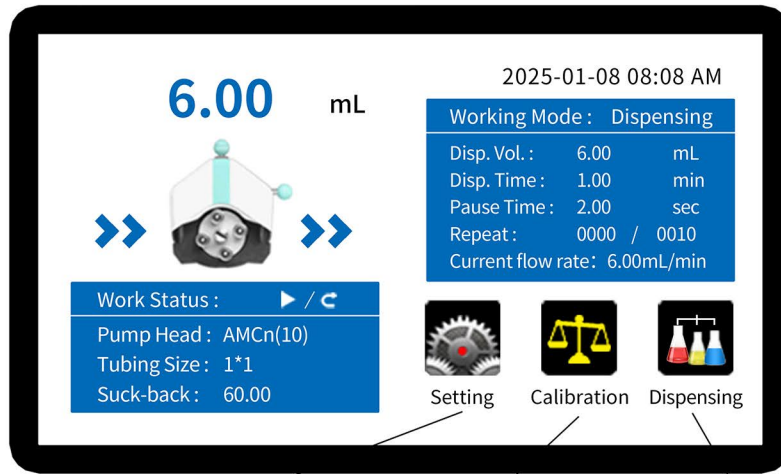

Setting

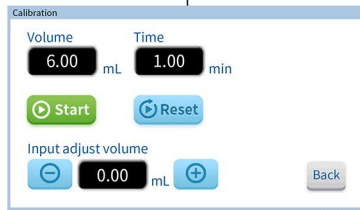

Calibration

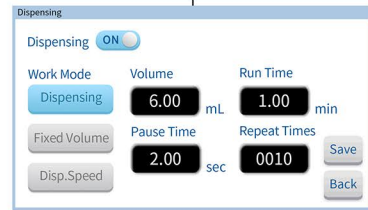

Dispensing

## Pump Head

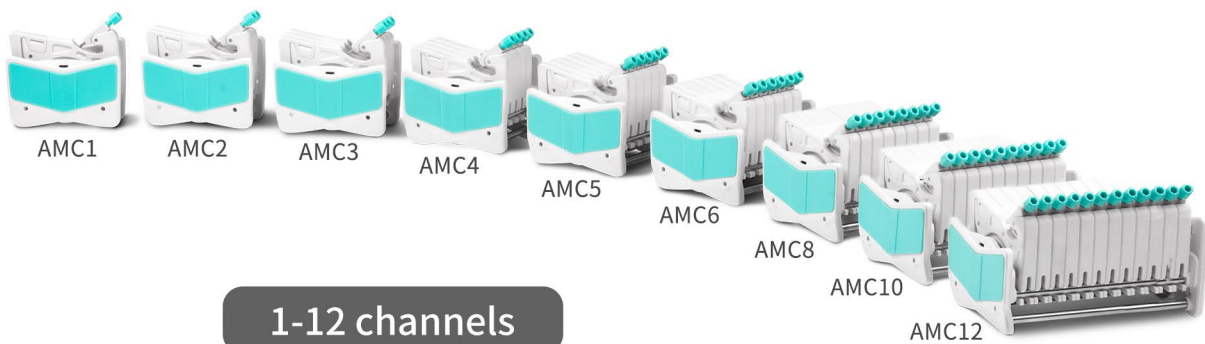

Pump Head	Tubing Size	Speed	Flow rate(mL/min)
AMC1-AMC12(10)	ID: 0.13-3.17mm, Wall: 0.8-1mm	0.1-150rpm	0.0002-48
AMC1-AMC12(6)			0.0002-65



■ Dimension Drawing(mm)

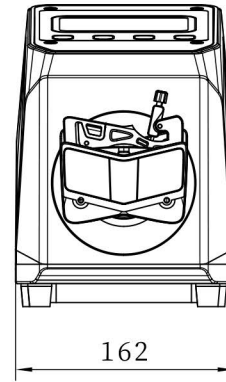
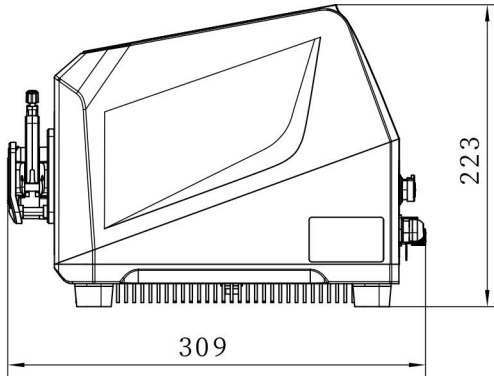



## Specifications

EMC Standard	IEC 61000-6-2/IEC 61000-6-4/IEC 61000-3-2/IEC 61000-3-3
Housing material	Stainless Steel 304
Speed range	0.1-150 rpm
Speed adjustment resolution	0.01 rpm
Display	4.3 inch-industrial grade- colorful LCD screen
Control modes	Touch screen, mechanical keypad, external control signal control, communication control
Working modes	Transferring mode, dispensing mode (Fixed volume, dispensing, speed dispensing)
Transferring mode	Continuous operation at set flow rate and speed
Dispensing mode	Dispensing: Set volume, time, repeat numbers, pause time
	Dispensing: set volume, flow rate, repeat numbers, pause time
	Speed dispensing: set speed (rpm), time, repeat numbers, pause time
Dispensing volume range	0.1ml - 9999L
Dispensing time range	0.1s - 9999h
Pause time range	0.5s - 9999h
Repeat numbers	1-9999 times, 0 means unlimited times
Calibration	Automatic calibration after inputting actual running liquid volume
Back suction angle	0-360°
Communication interface	RS485 or Ethernet for option
Communication protocol	Modbus protocol (RTU mode)
External control speed signal	0-5V, 0-10V, 4-20mA (for option)
External control signal input	Active switch signal (5-24V) controls start/stop, direction; Passive switch signal controls start/stop
Signal output	Open collector output operation status;4-20mA output
Open cover to stop pump function	Prevent misoperation and effectively protect user safety
three levels of permissions	Reasonable configuration of operation permissions
Drive dimension	268mm*162mm*223mm (L*W*H)
Power supply	AC110-220V±10%,50/60Hz
Rated power	100W
Working environment	0-40°C
Drive weight	11.5kg
Relative humidity	<100%
Protection level	IP66



■ IP Ratings



0	NO protection	NO protection	0
1	Solid foreign objects diameter >50mm	Vertical dripping water	1
2	Solid foreign objects diameter >12mm	Dripping water when tilted at 15°	2
3	Solid foreign objects diameter >2.5mm	Spraying water	3
4	Solid foreign objects diameter >1mm	Splashing water	4
5	Dust protected	Water jets	5
6	Dust-tight	Powerful water jets	6
		Short time immersion, up to 1 meter depth	7
		Continuous immersion, 1 meter or more depth	8