

Model No. : OEM-AMCB001



Flow Data

AMC Series pump head Technical Specifications									
Channel number	1	2	3	4	5	6	8	10	12
Rollers material	304 stainless steel material								
Rollers number	10 rollers, 6 rollers								
Tubing	Speed	Flow rate of pump head with 10 rollers(mL/min)	Flow rate of pump head with 6 rollers(mL/min)	Tubing Max.Pressure(Mpa)					
				Intermittent	Continuous				
1×1	0.1~150rpm	0.0050~7.55	0.0062~9.36	0.1	0.1				
2×1		0.0183~27.52	0.0220~33.06						
2.4×0.8		0.0254~38.13	0.0319~47.81						
3×1		0.0323~48.38	0.0434~65.17						
0.13×0.86		0.0002~0.29	0.0002~0.31						
0.19×0.86		0.0003~0.44	0.0003~0.46						
0.25×0.86		0.0005~0.76	0.0005~0.80						
0.51×0.86		0.0013~2.00	0.0014~2.05						
0.89×0.86		0.0030~4.47	0.0031~4.65						
1.14×0.86		0.0061~9.16	0.0065~9.74						
1.42×0.86		0.0125~18.75	0.0142~21.28						
2.06×0.86		0.0197~29.60	0.0234~35.17						
2.79×0.86		0.0286~42.86	0.0372~55.77						

Motor Specification

Model No.	OEM-AMCB001
Speed range	0.1-150rpm
Flow rate range	0.0002-65.17mL/min
Motor type	42 stepper motor
Motor phase number	2
Motor step angle	1.8°
Motor phase current	1.7A
Working environment	0-40°C, 80%RH

Dimension Drawing (Unit:mm)

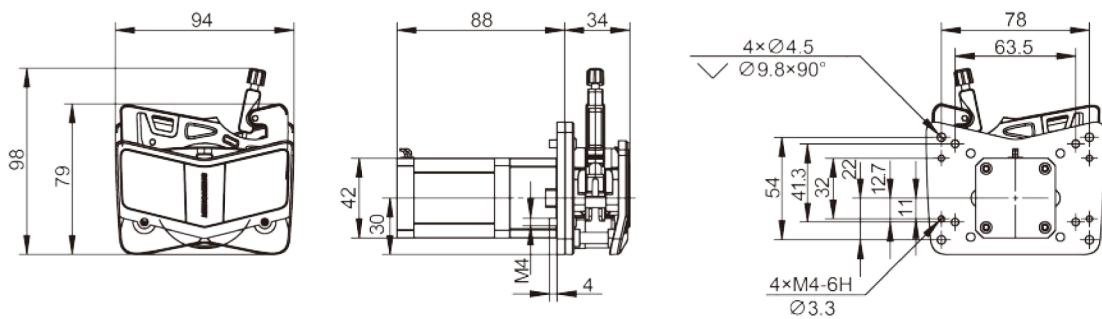

Note: Increasing or reducing one channel, the pump head size need to increase or reduce the thickness of one cartridge.

Tubing Installation Procedure



1. Easily press the elastic lock arm mechanism to open the cartridge.



2. After the cartridge is disconnected, install the tube, the two adjacent tube stoppers determine a working position.



3. Press the cartridge to make the cartridge enter the working position.



4. Pull the pressing device to enter the pressure tube state.



5. Installation finished. Turn the knob to adjust the pressure tubing gap according to the tubing size.